

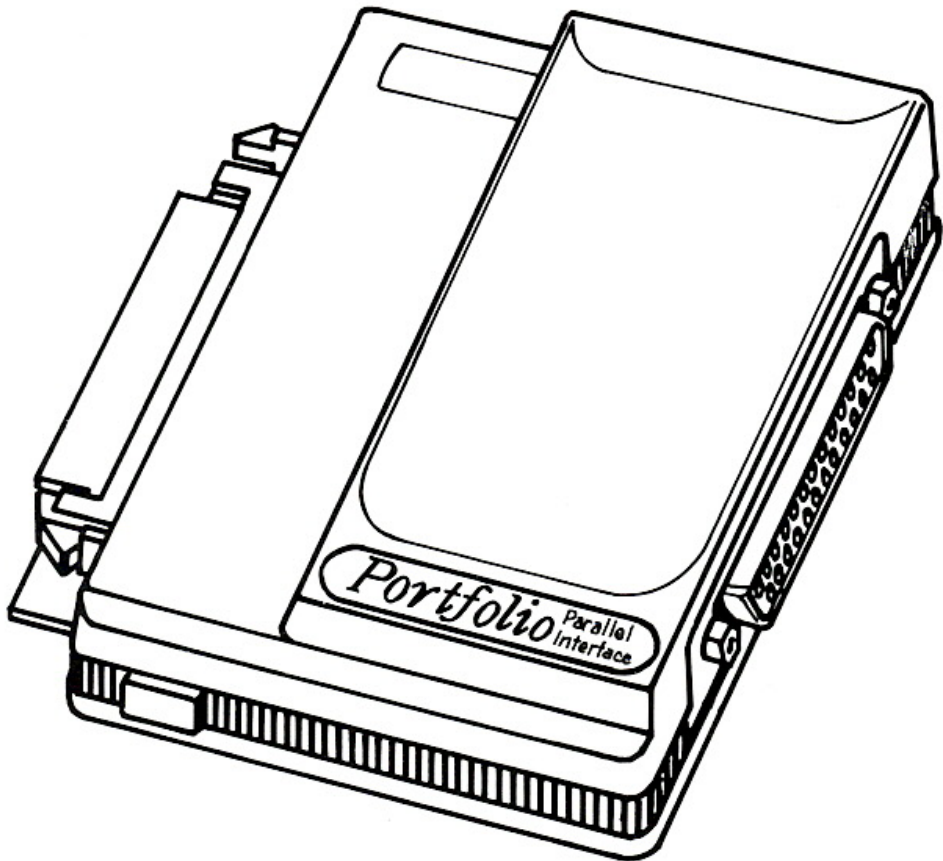

Portfolio[™]

Smart Parallel Interface



Owner's Manual

Reproduction of this document or of any portion of its contents is not allowed without the specific consent of Atari Corporation. Atari Corporation is unable to guarantee the accuracy of printed material after the date of publication and disclaims liability for changes, errors, or omissions.

Copyright in this manual and the software contained on the file transfer disks is vested in Distributed Information Processing Limited (DIP). In addition, the software is subject to the enclosed software license agreement. Accordingly, no part of the copyright material may be reproduced, stored in a retrieval system, or transmitted in any form or by any means without the prior written permission of DIP.

DIP is a trademark of Distributed Information Processing Ltd. IBM, PS/2, AT, and XT are registered trademarks or trademarks of International Business Machines Corporation. Lotus 1-2-3 is a registered trademark of Lotus Development Corporation. Centronics is a registered trademark of Centronics Data Computer Corp. MS-DOS is a registered trademark of Microsoft Corporation. Epson is a registered trademark of Seiko-Epson Corporation, Japan. Phoenix, Award, Compaq, and Amstrad are trademarks of companies of the same name.

Atari, the Atari logo, and Portfolio are trademarks or registered trademarks of Atari Corporation.



Copyright © 1989, Distributed Information Processing, Ltd.
Copyright © 1989, Atari Corporation, Sunnyvale, CA 94086
All rights reserved.

TABLE OF CONTENTS

INTRODUCTION	1
EQUIPMENT SUPPLIED	1
Additional Equipment Needed.....	2
INSTALLING THE PARALLEL INTERFACE	4
DE-INSTALLING THE PARALLEL INTERFACE	5
PRINTING	5
Preparing to Print	5
Destination	6
Lines Per Page	6
Setup Code	6
End of Line	7
Margins	7
Printing from Internal Applications	8
Address Book, Editor, Diary	8
Worksheet	8
Calculator	9
Printing from DOS	9
Printing the Screen Contents	9
FILE TRANSFER	10
INSTALLING THE FILE TRANSFER SOFTWARE ON A PC	10
Hard Disk	10
Floppy Disk	11
USING FILE TRANSFER	11
Menu Driven	11
Command Line Use	14
Using FT in Batch Files	15
TRANSFER SPEED	16
APPENDIX A. ERROR MESSAGES	17
APPENDIX B. TROUBLESHOOTING	21
APPENDIX C. PORTFOLIO PARALLEL CABLE PINOUT	25
CUSTOMER SUPPORT	27
PORTFOLIO™ END USER LICENSING AGREEMENT	29

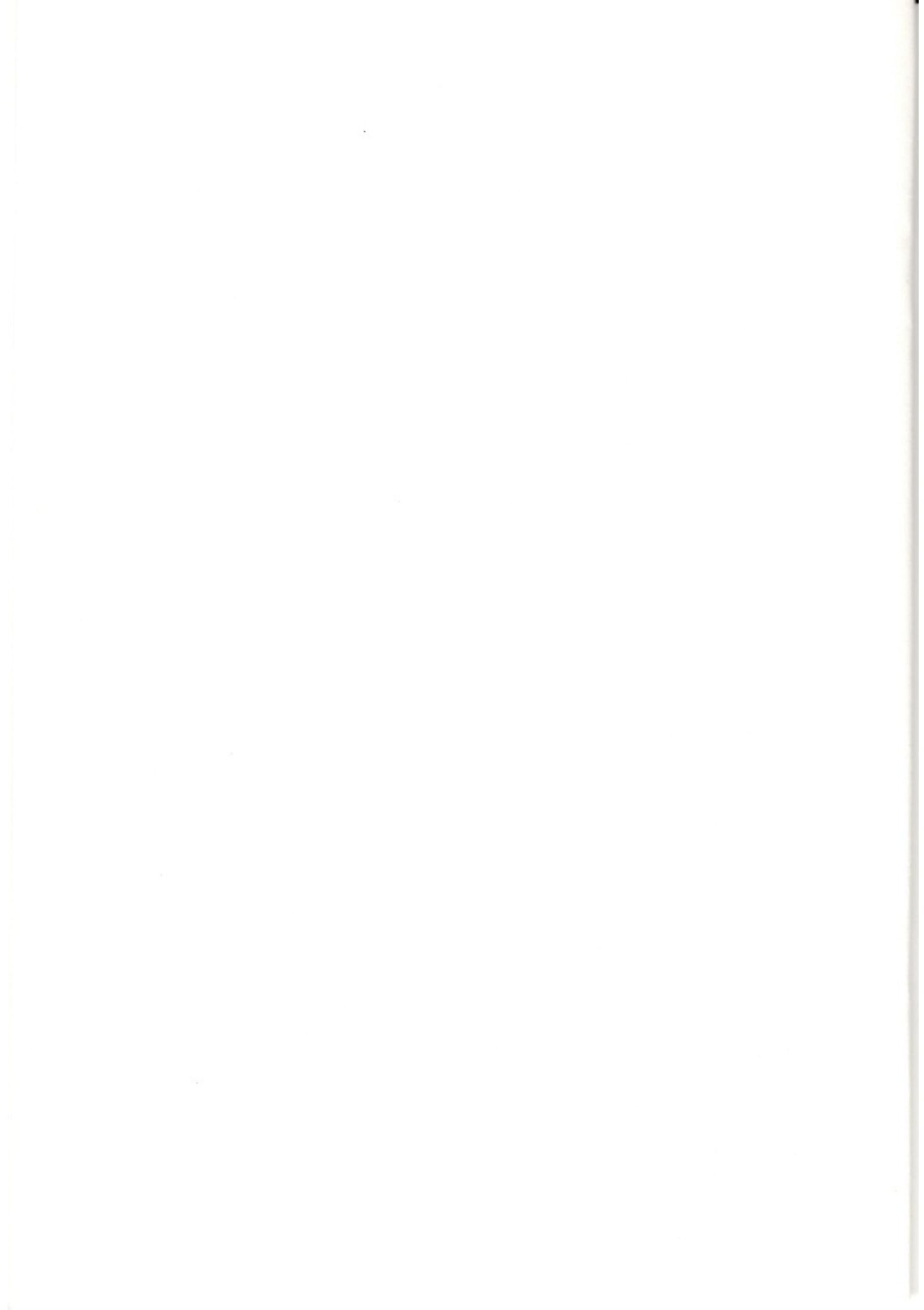

INTRODUCTION

The Portfolio Smart Parallel Interface can be used to:

- Print files from DOS or from the internal Portfolio programs to a printer with a parallel interface port.
- Print the contents of the screen to a parallel printer.
- Send and receive files between Portfolio and an IBM PC, PC/AT or compatible computer.
- Communicate with other devices having a standard parallel interface.

EQUIPMENT SUPPLIED

This optional Portfolio interface product consists of:

- The parallel interface which plugs into the bus connector on the right side of the Portfolio.
- A 5¼ inch floppy disk containing the PC file transfer software for IBM PCs or compatibles.
- A 3½ inch floppy disk containing the PC file transfer software for IBM PCs or compatibles.
- A software license agreement and warranty card.



Additional Equipment Needed

The following equipment is required for printing:

- A parallel printer. Preferably a printer supporting the IBM extended character set.
- A standard shielded parallel printer cable (25 pin D-type male connector to Centronics connector). You can probably use your existing printer cable.

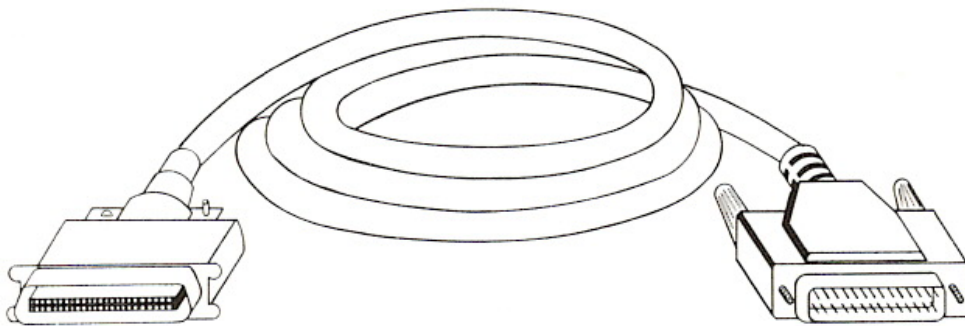

- If you wish to attach the shielded cable connectors to the Portfolio or printer, you will need a small screwdriver.

You will need the following equipment for file transfer:

- An IBM PC, AT, PS/2 or compatible computer with an IBM, Phoenix, Award, Compaq, Amstrad or other high quality BIOS.
- A 5¼ inch or 3.5 inch floppy disk drive on the PC.
- A parallel interface card installed on the PC.
- MS-DOS version 2 or above for the PC.
- A shielded cable with a 25 pin D-type male connector on each end, or an adaptor to convert Centronics to 25 pin D-type connector to use with your normal printer cable.

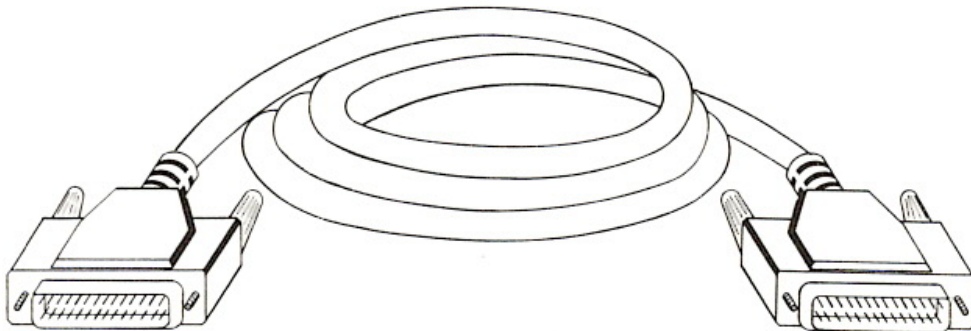

- If you wish to attach the shielded cable connectors to the Portfolio or printer, you will need a small screwdriver.

It is advisable to use an A.C. adaptor with Portfolio during file transfer. Power consumption is higher than in normal use, and drains batteries faster than normally.

INSTALLING THE PARALLEL INTERFACE

To install the parallel interface, follow the steps listed below:

1. Switch off the Portfolio by typing **OFF** and pressing [J] or by holding down the [Fn] key and pressing [O] (for OFF), releasing [O] before [Fn].
2. Turn Portfolio on its back. Carefully remove the bus connector cover on the right end by pressing the outer edge inwards and up as shown.

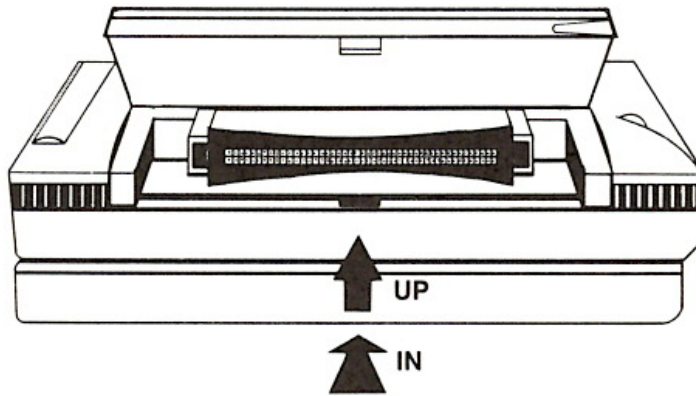

3. Slide the parallel interface into the expansion connector until there is an audible click from both safety catches.
4. Connect the correct cable for printing or file transfer.
5. Switch on the printer or PC.
6. Switch on the Portfolio by pressing any key.

If the Portfolio is not switched off while you connect the parallel interface, it is necessary to initialize the interface. Hold down [Ctrl] and [Alt], and press [Del], or switch the interface OFF and ON as above.

DE-INSTALLING THE PARALLEL INTERFACE

To de-install the parallel interface, follow the steps listed below:

1. Switch off the Portfolio. Type **OFF** and press [J], or hold down [Fn] and press [O].
2. Press the release buttons on the front and back of the interface and pull the interface out of the bus expansion connector.

PRINTING

Preparing to Print

First set up the printer parameters from the Setup menu.

If the applications menu is displayed, press [S] to select Setup, or if you are in another application or within DOS, hold down the [^] key and press [S]. Or, type **APP IS** from DOS.

Press [P] to select the Printer option.

The Printer menu is shown below:

Printer	
Destination	Parallel
Lines per page	66
Setup code	
End of line...	CR-LF
Margins...	

Destination

If the destination is not set to parallel, press **[D]** to select Destination. Then press **[P]** for parallel.

Lines Per Page

You can set the number of lines per page to 0, in which case no page breaks are inserted (use this setting only if you are using continuous forms paper), or to a number from 41 to 99, according to the length of your paper.

The standard page length for 8½ x 11 inch paper, and the default for this option, is 66 lines.

Note: The Portfolio does not pause between printing individual pages.

Setup Code

This option allows you to send a sequence of up to 128 characters to the printer to set a suitable print mode. Refer to your printer manual for further information.

If you do not know whether or not you need a setup code, try printing without a setup code.

If you wish to send a control character, prefix it with a backslash **[\]** followed by the three digit ASCII number of the character in decimal. Or, type a caret (^) (**[Shift] [6]**) followed by the character, for example **[Ctrl] [Z]** is **^Z**. For example, many printers accept a code of **[Ctrl] [O]**, which is decimal 15, to select condensed print. In this case, type in **\015**, or **^O**.

End of Line

At the end of each printed line, printers usually expect a carriage return (CR) or a line feed (LF) character or both. The most usual line ending is both CR and LF.

Find the correct end of line sequence in your printer manual. If you cannot find the correct sequence, try printing with CR-LF first. If the output is double-spaced (in other words, there is a blank line between each line of text), select CR. If your text is single spaced with CR-LF and you want to print double spaced text, set this option to CR-LF-LF.

Margins

Use this option to design the page layout.

The top, bottom and left margins can be set to any value from 0 to 20. The right margin is not set through the Setup menu, but is set individually by each application.

The left margin is the number of columns which are unused between the left edge of the page and the main body of text. The default is 8.

The top margin is the number of blank lines between the top of the paper and the text. The default is 6.

The bottom margin is the number of blank lines below the text before the bottom of the paper. The default is 2.

The number of lines printed on each page is determined by the top margin, the bottom margin and the Lines per page command described above. The number of lines per page includes the top margin and the bottom margin. Since the default number of lines per page is 66, the default number of text lines on each page is 58 ($66 - 6 - 2 = 58$).

Printing from Internal Applications

Enter the application in the usual way and load the file you wish to print.

Press **[F1]** (or press and release the **[^]** key) to view the main menu.

Address Book, Editor, Diary

Press **[F]** to select the Files menu, and **[P]** to print.

The **Printing...** message will appear on the screen. Stop printing at any time by pressing **[Esc]**.

The file should print successfully, and the last page eject from the printer as all printed output ends with a Form Feed (ASCII 12) character.

If the printer tries to print beyond the right edge of the paper, either reduce the left margin in Setup, or reduce the width of the text in the application.

Worksheet

Spreadsheets are often wider than the available paper. You might wish only to print a portion (range) of a spreadsheet. Select the Range option from the spreadsheet menu from **Files...** to **Print...** to **Range**.

The Width setting is on the spreadsheet menu under **Files ...**, then **Print...** Width sets the number of printed characters per line and thus determines the right margin.

Any portion of the spreadsheet which extends beyond the right margin will print on the next page, before the lower parts of the sheet.

To initiate printing, select **GO!** from the **Files... Print** menu.

Calculator

If the printer is set to ON in the calculator's menu, the calculation will print every time you press [J].

Note: The calculator always sends a form-feed at the end of each printed calculation, even if a page length of zero is selected in Setup.

Printing from DOS

Print a file directly from the DOS command line by typing:

```
COPY FILENAME.EXT LPT1 [J]
```

or

```
COPY FILENAME.EXT PRN [J]
```

This form of printing does not use the page layout information in Setup.

Printing the Screen Contents (PrtSc)

Print the contents of the screen by holding down the [Fn] key and pressing [P].

If the External Display mode is set to Static PC or Tracked PC in Setup (refer to the **Portfolio Owner's Manual** for more information on these options), then the full 80 character by 25 line virtual screen contents will print. Otherwise, only the visible 40 character by 8 line display will print.

Print Screen does not use the printer settings in Setup.

Note: If an error occurs during Print Screen, no message will be displayed.

FILE TRANSFER

File transfer allows you to send and receive files between the Portfolio and an IBM PC, PC/AT, or compatible.

You can select which machine controls the communications by choosing which one is the file server. The server remains passive during communications, responding to commands from the other computer.

If you transfer a large number of files, it is best to set the Portfolio into server mode. This allows you to transfer multiple files with a single command.

INSTALLING THE FILE TRANSFER SOFTWARE ON A PC

Hard Disk

1. Insert whichever disk fits your computer's floppy disk drive in drive A:
2. At the DOS prompt, C: (or the drive letter of your hard disk), type the following.

```
MD IFT [↵]  
CD IFT [↵]  
COPY A:*. * [↵]
```

3. Select the language you want by typing one of the following and pressing [↵]:

ENGLISH FRANCAIS DEUTSCH

Note: This will only select the language if you have followed the instructions above and are in the same subdirectory as the FT program.

Floppy Disk

It is advisable to make a backup of the FT disk first. Then follow steps 1 and 3 above, skipping step 2.

USING FILE TRANSFER

Make sure that the parallel interface is installed correctly according to the instructions above.

Access FT (the file transfer program) directly from the command line, or use menus to guide you.

Warning: If you use file transfer to send desktop MS-DOS programs to Portfolio, see **Setup** in your **Portfolio Owner's Manual** concerning screen modes before attempting to run the programs on Portfolio.

Menu Driven

Type FT [J].

The screen will show the options:

Transmit Receive Server List Quit

Option	Description
Transmit	Sends files from the PC to the Portfolio.
Receive	Sends files from the Portfolio to the PC.
Server	Sets the current side of the communications link to Server. Communications are controlled from the other computer. Note: One transmission side, either the PC or the Portfolio, must be set to Server.
List	Displays a directory of files on Portfolio on the PC.
Quit	Returns to DOS.

Whether you transmit or receive files, the procedure is similar. First decide which end should control the communications. Assuming you have chosen the PC, set the Portfolio to Server.

1. Enter Setup by holding down **[A]** and pressing **[S]**. Alternatively, from DOS or a batch file, type **APP /S**.
2. Press **[F]** to select the File transfer option.
3. Press **[S]** for Server mode. The message:

Waiting for connection ...

will appear.

4. On the PC select either **[T]** to transmit or **[R]** to receive.
5. Enter the filename you wish to transmit or receive, and press **[J]**.

If the Portfolio is controlling communications and the PC is set into server mode, it is not possible to transfer multiple files using wildcards. Specifying *.* on the Portfolio will display a list of files in the current directory.

6. Then enter the name the file should be called after file transfer.

In both cases you may specify drives, directories and wildcards.

For example you may wish to send all your .WKS worksheet files from the subdirectory C:\123 on your desktop PC to the subdirectory A:\DATA on a memory card installed in the Portfolio.

1. On the Portfolio, select the File Transfer option in Setup. Press **[S]** for Server mode.
2. On the PC, select **[T]** for Transmit.

The screen shows:

Transmit which PC files?:

3. Type the following.

C:\123*.WKS [J]

The screen then shows:

To where on Portfolio? :

4. Type the following.

A:\DATA*.WKS [J]

FT will report as each file is sent whether the transmission was successful or not.

If a file of the same name as the file being transferred exists on the target, an overwrite confirmation displays. Press **[Y]** to overwrite the file, **[N]** to continue file transfer, skipping this file, or **[Esc]** to terminate file transfer.

If you wish to list the directory of files on the Portfolio, press **[L]** for List. You may specify directories and pathnames where the files are located, but you cannot list directory names. For example, to list all the files on C:\SYSTEM on the Portfolio, press **[L]** for list. Type **C:\SYSTEM*. * [J]** and the list of files displays.

Command Line Use

Once you are familiar with the way file transfer works, you can give the whole file transfer instruction on the command line. This takes the form:

FT <source file> <destination file> /t/r/s//e//d/?

Drives, directories and wild cards can be used in the source and destination filenames.

If the filename will remain the same after transfer, and it is to be sent or received to the current directory, the destination filename need not be specified. (This is similar to the way the DOS COPY command works.)

For example, assume the current Portfolio directory is C:\SYSTEM and it contains the file DIARY.DRY, which you wish to transfer to the current PC directory, for example C:\FT. The normal form of:

FT C:\SYSTEM\DIARY.DRY C:\FT\DIARY.DRY /r

can be shortened to:

FT DIARY.DRY /r

Use the switches as follows:

Switch	Purpose
/t	Transmit files to the Portfolio
/r	Receive files from the Portfolio
/s	Server mode (remember one end must be in Server mode)
//	List a directory of Portfolio files
/e	Set the FT prompt language to English
/f	Set the FT prompt language to French
/d	Set the FT prompt language to German
/?	Help screen

Using the same example as in the Menu Driven section above, transmit all your spreadsheet files to the Portfolio's memory card by setting the Portfolio to Server, then type the following on the PC:

```
FT C:\123\*.WKS A:\DATA\*.WKS /t [J]
```

Note: No files are specified when using the /s (Server) option, or when changing the language with the /e, /f and /d switches.

Note also that only one file or pathname is accepted when using the /l (List) switch.

After executing the file transfer (even if transfer was unsuccessful), you are returned to DOS.

Using FT in Batch Files

Use the command line syntax described above.

FT returns an ERRORLEVEL of 0 if transfer was completely successful, 1 if only some files were transferred, and 2 if transfer failed completely. The ERRORLEVEL only applies to the last file transfer job.

Use this feature in a batch file as follows:

```
echo off  
ft %1 %2 %3 %4  
if errorlevel 2 goto failed  
if errorlevel 1 goto half  
echo File transfer successful  
goto quit  
:HALF  
echo Warning: Not all files were transferred  
successfully  
goto quit  
:FAILED  
echo File transfer unsuccessful; No files transferred.  
:QUIT
```

TRANSFER SPEED

File transfer uses a proprietary communications protocol that checks for errors during transmission. File transfer starts by aligning the PC and Portfolio, which can take a few seconds before actual transfer starts. Thereafter the transfer rate is approximately 200 characters per second, although this may vary.

Note: Although file transfer uses the parallel port, files are transmitted serially (synchronous) for compatibility with all PC parallel cards. Therefore you do not need the parallel card on the PC to be bi-directional.

APPENDIX A ERROR MESSAGES

BAD FILENAME

The destination filename specified characters that DOS does not permit, or the whole name is a DOS reserved word (such as PRN, DIR or LPT1). Choose a different name.

CANNOT CHANGE LANGUAGE IN FT.COM FILE IS WRITE PROTECTED

Changing the prompt language makes a physical change to the FT program. This cannot take place if the FT.COM program has been set to read-only. Remove the read-only protection by using a utility program such as ATTRIB, and try again.

COMMUNICATIONS ERROR

File transfer failed because the file server side is not responding correctly. Make sure that file transfer is running on both ends, that one computer is set to Server mode, and that the connections are electrically sound.

DEVICE WRITE FAILURE

An error has occurred printing to a file. The disk may be full or damaged.

DISK FULL OR DIRECTORY DOES NOT EXIST

The file transfer software on the Portfolio has been unable to successfully transfer the entire file. This may be due to the Portfolio's disk being full or a corrupt card. This error will also occur if a file is transmitted to the Portfolio and a subdirectory of the same name as the file already exists.

DISK FULL

The receiving side of File Transfer has run out of disk space. Possibly Portfolio's internal disk or memory card or the PC's directory does not have enough free space to store the file being transferred. Make space by moving or deleting files and try again. This message may also be displayed if trying to send a file to a non-existent sub-directory.

FILE COULD NOT BE CREATED

For one of several reasons, the file being transferred could not be created on the receiving machine. The card or disk may be corrupt, or the root directory may be full, or the target file has attributes preventing it from being written to (such as read-only).

FILE COULD NOT BE OPENED

The file disappeared during file transfer. This could be due to a memory card being removed from Portfolio.

FILE NOT FOUND

This Portfolio message displays when the specified source file does not exist. Remember that you can get a directory of files on the Portfolio by using a wildcard such as *.

FT.COM MUST BE IN THE CURRENT DIRECTORY FOR LANGUAGE CHANGES TO BE PERMANENT

An attempt has been made to change the prompt language of FT from another directory (by typing **!FT!FT //** from the root directory, for example). As a result, the change is only temporary. Use the CD command to change to the directory where FT is present before attempting to change the language permanently.

ILLEGAL COMBINATION OF SWITCH OPTIONS

The optional switches are normally used individually. Only the following combinations are valid:

<u>Switch</u>	<u>Mode</u>	<u>Language</u>
/t/e	Transmit mode	English
/t/f	Transmit mode	French
/t/d	Transmit mode	German
/r/e	Receive mode	English
/r/f	Receive mode	French
/r/d	Receive mode	German
/s/e	Server mode	English
/s/f	Server mode	French
/s/d	Server mode	German
//e	List files	English
//f	List files	French
//d	List files	German

<LANGUAGE> INSTALLED

The language you have selected has been installed permanently. There is no need to specify language the next time you use File Transfer.

NO FILES FOUND

The source file or files specified to be transferred were not found on the disk. Check the name and path, and try again.

NOT READY ERROR ABORT, RETRY, IGNORE?

This printing error can occur when copying a file to LPT1 or PRN from DOS. Check the connections and make sure the printer is on line and has paper.

APPENDIX B

TROUBLESHOOTING

PRINTING

Q: The printer prints everything on one line.

A: The end of line option in Setup is set to CR. Change it to CR-LF.

Q: When the **Files... Print** option is selected, the printer does nothing but the applications display **Printing ...**

A: The applications may display a printing message even if no printing is taking place. The printer may be off-line. Turn on the printer, check the connections, and make sure it is on line. Check that the Print destination in Setup is set to parallel, not file.

Q: When the **Files... Print** option is selected, the printer does nothing and there is a delay of a few seconds before the applications display **Printing ...**

A: The Portfolio has not been initialized after the parallel peripheral was connected. Exit to DOS and reboot by holding down the **[Ctrl]** and **[Alt]** keys and pressing **[Del]**.

Q: Printer is not form-feeding after each page

A: Page length in Setup is set to 0. Try 66, or the length of your paper.

Q: Printer is form-feeding at wrong place.

A: The Page Length value in Setup is incorrect. The length can be set to any number of lines between 41 and 99. If unsure, try 66. If you want to stop the form-feeds, select a page length of 0.

Q: Printer prints different characters from those on the Portfolio.

A: The printer is not in IBM mode. Portfolio uses the IBM character set. Certain characters (for example £ and box drawing characters) are not in the same position as other printer character sets, such as the Epson standard. Set your printer to IBM mode, if possible.

FILE TRANSFER

Q: The system seems to freeze up.

A: Check the connections, and ensure that both ends are running File Transfer, and that one side is set up as the File Server. Make sure that the parallel interface is initialized correctly.

Q: The connections are all OK but nothing happens.

A: Check that the parallel port on the PC (LPT1) has not been redirected (using for example MODE). If you are connected to a network: log out, reboot the PC and try again. Check that no memory resident programs such as a print spooler are running. Also make sure that the parallel interface is initialized.

Q: One particular file fails consistently to transfer.

A: Check that it does not have a length of zero. If it does, delete it and try again.

Q: The File Overwrite option fails.

A: Check that the file is not write protected.

Q: DOS programs transfer but do not run on Portfolio.

A: The screen mode or refresh may not be set up correctly. Consult the **Setup** chapter in your **Portfolio Owner's Manual**. Or the program may be "ill-behaved" assuming hardware features that are different or not present on Portfolio.

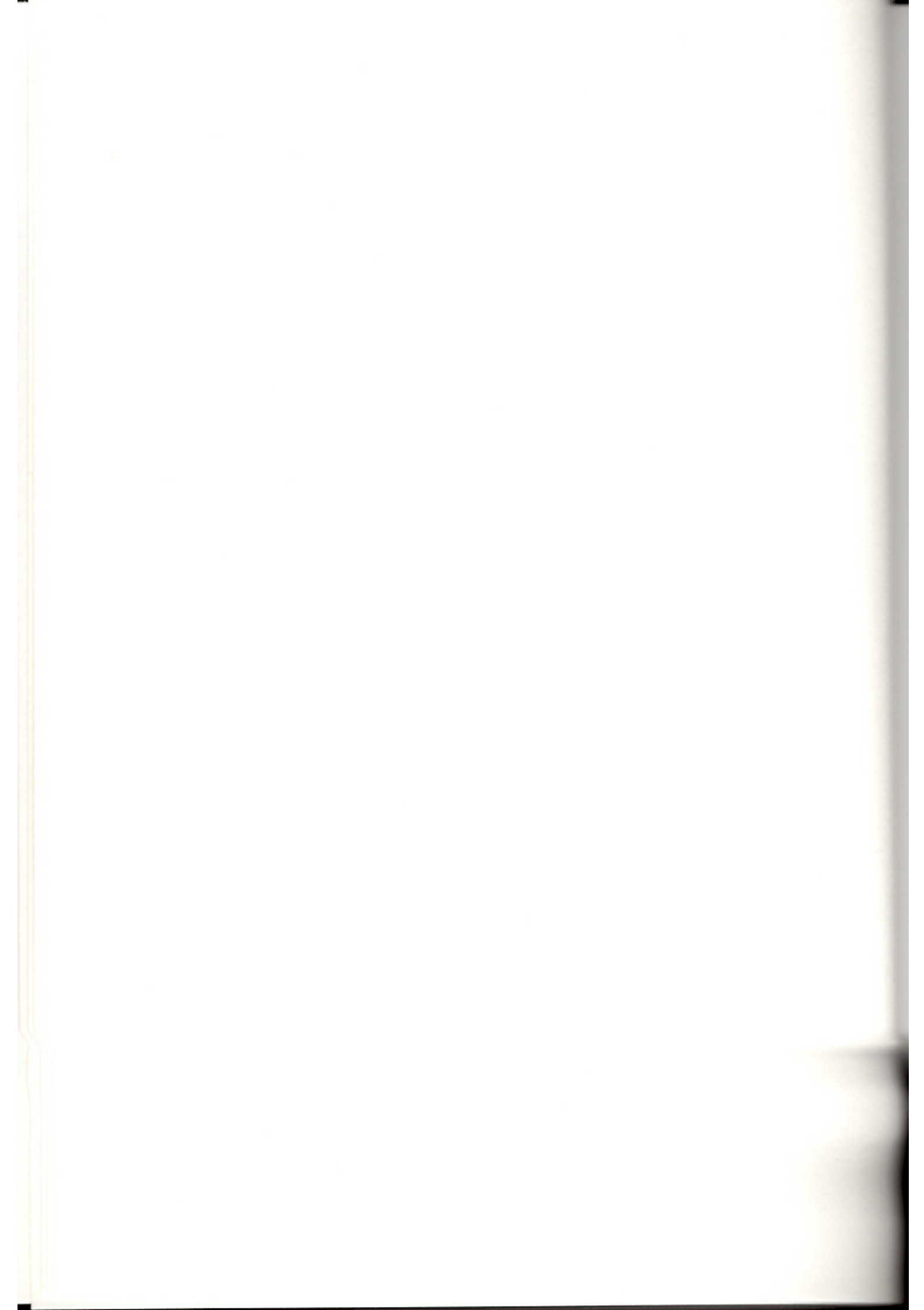

APPENDIX C

PORTFOLIO PARALLEL CONNECTOR PINOUT (DB-255)

<u>Pin</u>	<u>Direction</u>	<u>Signal</u>
1	OUT	Strobe
2	OUT	Data 0
3	OUT	Data 1
4	OUT	Data 2
5	OUT	Data 3
6	OUT	Data 4
7	OUT	Data 5
8	OUT	Data 6
9	OUT	Data 7
10	IN	Acknowledge
11	IN	Busy
12	IN	Paper Error
13	IN	Select
14	OUT	Auto Feed
15	IN	Error
16	OUT	Initialize Printer
17	OUT	Select Input
18 - 25		Ground

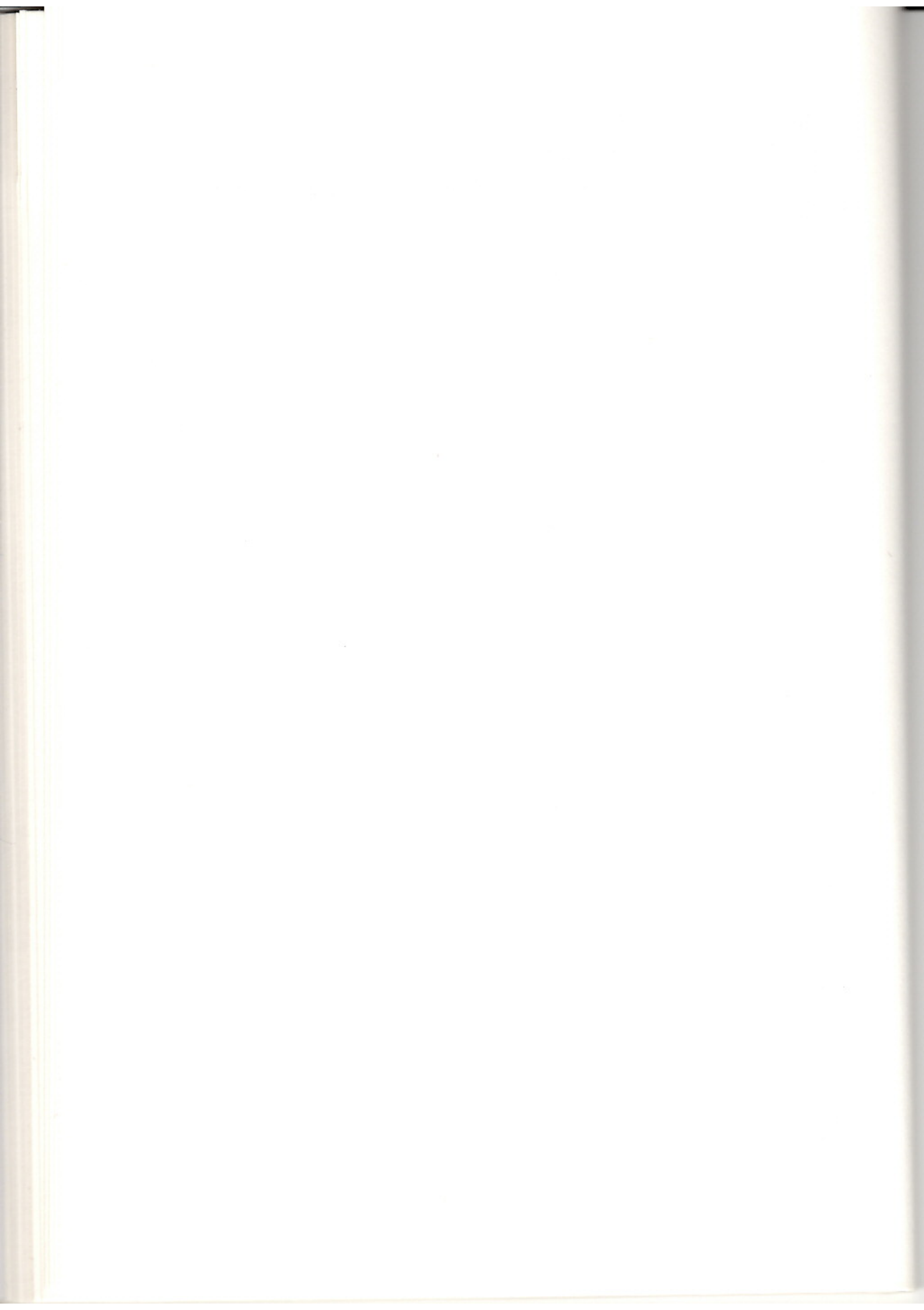

CUSTOMER SUPPORT

Atari Corporation welcomes inquiries about your Atari computer products. We also provide technical assistance. Write to **Customer Relations** at an address listed below.

Atari user groups also provide outstanding assistance. To receive a list of Atari user groups in your area, send a self-addressed, stamped envelope to an address below.

In the United States, write to:

Atari Corporation
Customer Relations
Post Office Box 61657
Sunnyvale, CA 94088

In Canada, write to:

Atari (Canada) Corp.
90 Gough Road
Markham, Ontario
Canada L3R 5V5

In the United Kingdom, write to:

Atari Corp. (UK) Ltd.
Post Office Box 555
Slough
Berkshire SL2 5BZ

Please add to the outside of the envelope: **User Group List** and the name of the state where you live, or **Technical Assistance**, or the subject of your letter.



ATARI® CORPORATION END USER LICENSING AGREEMENT

YOU SHOULD CAREFULLY READ THE FOLLOWING TERMS AND CONDITIONS BEFORE OPENING THE DISK PACKAGE. OPENING THE DISK PACKAGE INDICATES YOUR ACCEPTANCE OF THESE TERMS AND CONDITIONS. IF YOU DO NOT AGREE WITH THEM, YOU SHOULD PROMPTLY RETURN THE PACKAGE UNOPENED AND YOUR MONEY WILL BE RETURNED.

You assume responsibility for the selection of the program to achieve your intended results, and for the installation, use and results obtained from the program.

LICENSE

You may:

- a. use the program on a single machine;
- b. copy the program into any machine readable or printed form for backup or modification purposes in support of your use of the program on the single machine;
- c. modify the program and/or merge it into another program for your use on the single machine. (Any portion of this program merged into another program will continue to be subject to the terms and conditions of this Agreement.); and,
- d. transfer the program and license to another party if the other party agrees to accept the terms and conditions of this Agreement. If you transfer the program, you must at the same time either transfer to the same party all copies, whether in printed or machine-readable form or destroy any copies not transferred; this includes all modifications and portions of the program contained or merged into other programs.

You must reproduce and include the copyright notice on any copy, modification or portion merged into another program.

YOU MAY NOT USE, COPY, MODIFY, OR TRANSFER THE PROGRAM OR ANY COPY, MODIFICATION OR MERGED PORTION IN WHOLE OR IN PART, EXCEPT AS EXPRESSLY PROVIDED FOR IN THIS LICENSE.

IF YOU TRANSFER POSSESSION OF ANY COPY, MODIFICATION OR MERGED PORTION OF THE PROGRAM TO ANOTHER PARTY, YOUR LICENSE IS AUTOMATICALLY TERMINATED.

TERM

The license is effective until terminated. You may terminate it at any other time by destroying the program together with all copies, modifications and merged portions in any form. It will also terminate upon conditions set forth elsewhere in this Agreement, or if you fail to comply with any term or condition of this Agreement. You agree upon such termination to destroy the program together with all copies, modifications and merged portions in any form.

LIMITED WARRANTY

THE PROGRAM IS PROVIDED "AS IS" WITHOUT WARRANTY OF ANY KIND, EITHER EXPRESSED OR IMPLIED, INCLUDING, BUT NOT LIMITED TO, THE IMPLIED WARRANTIES OF MERCHANTABILITY AND FITNESS FOR A PARTICULAR PURPOSE.

THE ENTIRE RISK AS TO THE QUALITY AND PERFORMANCE OF THE PROGRAM IS WITH YOU. SHOULD THE PROGRAM PROVE DEFECTIVE, YOU (AND NOT ATARI CORPORATION OR AN AUTHORIZED PERSONAL COMPUTER DEALER) ASSUME THE ENTIRE COST OF ALL NECESSARY SERVICING, REPAIR OR CORRECTION.

SOME STATES DO NOT ALLOW THE EXCLUSION OF IMPLIED WARRANTIES, SO THE ABOVE EXCLUSION MAY NOT APPLY TO YOU. THIS WARRANTY GIVES YOU SPECIFIC LEGAL RIGHTS AND YOU MAY ALSO HAVE OTHER RIGHTS WHICH VARY FROM STATE TO STATE.

Atari Corporation does not warrant that the functions contained in the program will meet your requirements or that the operation of the program will be uninterrupted or error free.

However, Atari Corporation warrants the disk(s) on which the program is furnished to be free from defects in materials and workmanship under normal use for a period of ninety days from the date of delivery to you as evidenced by a copy of your receipt.

LIMITATIONS OF REMEDIES

Atari Corporation's entire liability and your exclusive remedy shall be:

1. the replacement of any disk not meeting Atari Corporation's "Limited Warranty" and which is returned to Atari Corporation or an authorized Atari Corporation computer dealer with a copy of your receipt; or

2. if Atari Corporation or the dealer is unable to deliver a replacement diskette or cassette which is free of defects in materials or workmanship, you may terminate this Agreement by returning the program and your money will be refunded.

IN NO EVENT WILL ATARI CORPORATION BE LIABLE TO YOU FOR ANY DAMAGES, INCLUDING ANY LOST PROFITS, LOST SAVINGS OR OTHER INCIDENTAL OR CONSEQUENTIAL DAMAGES ARISING OUT OF THE USE OR INABILITY TO USE SUCH PROGRAM, EVEN IF ATARI CORPORATION OR ANY AUTHORIZED ATARI CORPORATION PERSONAL COMPUTER DEALER HAS BEEN ADVISED OF THE POSSIBILITY OF SUCH DAMAGES, OR FOR ANY CLAIM BY ANY OTHER PARTY.

SOME STATES DO NOT ALLOW THE LIMITATION OR EXCLUSION OF LIABILITY FOR INCIDENTAL OR CONSEQUENTIAL DAMAGES, SO THE ABOVE LIMITATION OR EXCLUSION MAY NOT APPLY TO YOU.

GENERAL

You may not sublicense, assign or transfer the license or the program except as expressly provided in this Agreement. Any attempt otherwise to sublicense, assign or transfer any of the rights, duties or obligations hereunder is void.

This Agreement will be governed by the laws of the State of California.

YOU ACKNOWLEDGE THAT YOU HAVE READ THIS AGREEMENT, UNDERSTAND IT, AND AGREE TO BE BOUND BY ITS TERMS AND CONDITIONS. YOU FURTHER AGREE THAT IT IS THE COMPLETE AND EXCLUSIVE STATEMENT OF THE AGREEMENT BETWEEN US WHICH SUPERSEDES ANY PROPOSAL OR PRIOR AGREEMENT, ORAL OR WRITTEN, AND ANY OTHER COMMUNICATIONS BETWEEN US RELATING TO THE SUBJECT MATTER OF THIS AGREEMENT.



Copyright © 1989, Atari Corporation
Sunnyvale, CA 94086
All rights reserved.

Printed in Japan.

C301112-002 Rev. A